

# Retroreflective sensor

## GLV18-55/59/102/159

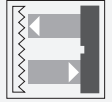

- Efficient Line in a short M18 plastic housing for standard applications
- Very high detection range
- 4 LEDs indicator for 360° visibility
- Optimized potentiometer design for a clear control button layout in the application
- Version with front optical face
- DC voltage version

Retroreflective sensor with polarization filter, M18 threaded housing design, plastic housing, front optical face, 4 m detection range, red light, dark on, DC version, NPN output, M12 plug



### Function

The GLV/GLK18 series sensors help improve the efficiency of machines and systems. The design of the M18 plastic housing, the connection technology, and sensor properties are highly standardized. Concentrating on the key sensor requirements has produced a robust and reliable product series for DC and AC/DC voltage systems without any over-engineering. The mounting set included in the scope of delivery and the optimized potentiometer design ensure fast assembly and easy configuration.

### Dimensions

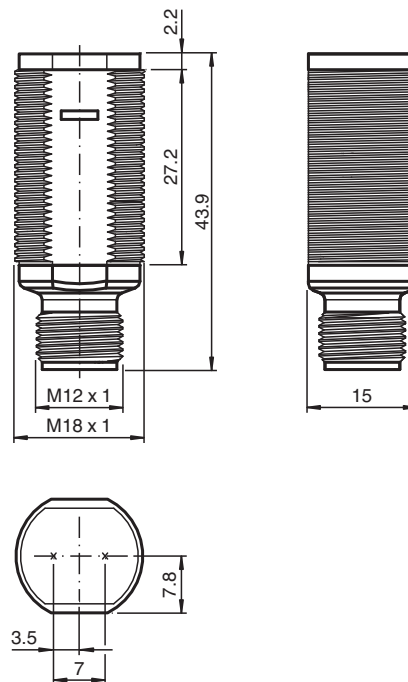

Release date: 2020-12-03 Date of issue: 2020-12-03 Filename: 188557\_eng.pdf

Refer to "General Notes Relating to Pepperl+Fuchs Product Information".

Pepperl+Fuchs Group  
www.pepperl-fuchs.com

USA: +1 330 486 0001  
fa-info@us.pepperl-fuchs.com

Germany: +49 621 776 1111  
fa-info@de.pepperl-fuchs.com

Singapore: +65 6779 9091  
fa-info@sg.pepperl-fuchs.com

**pf** PEPPERL+FUCHS

## Technical Data

General specifications		
Effective detection range		0 ... 4 m
Reflector distance		0.05 ... 4 m
Threshold detection range		5.5 m
Reference target		reflector C110-2
Light source		LED
Light type		modulated visible red light , 640 nm
Polarization filter		yes
Diameter of the light spot		approx. 200 mm at 5.5 m
Angle of divergence		approx. 2 °
Optical face		frontal
Ambient light limit		30000 Lux
Functional safety related parameters		
MTTF <sub>d</sub>		920 a
Mission Time (T <sub>M</sub> )		20 a
Diagnostic Coverage (DC)		0 %
Indicators/operating means		
Operation indicator		LED green, statically lit Power on
Function indicator		LED yellow: lights up when receiving the light beam ; flashes when falling short of the stability control; OFF when light beam is interrupted
Electrical specifications		
Operating voltage	U <sub>B</sub>	10 ... 30 V DC
No-load supply current	I <sub>0</sub>	< 20 mA
Output		
Switching type		dark on
Signal output		1 NPN, short-circuit protected open collector
Switching voltage		max. 30 V DC
Switching current		max. 100 mA
Voltage drop	U <sub>d</sub>	≤ 1.5 V DC
Switching frequency	f	500 Hz
Response time		≤ 1 ms
Conformity		
Product standard		EN 60947-5-2
Approvals and certificates		
Protection class		II, Rated insulation voltage ≤ 50 V AC with pollution degree 1-2 according to IEC 60664-1
UL approval		cULus Listed, Class 2 Power Source
CCC approval		CCC approval / marking not required for products rated ≤36 V
Ambient conditions		
Ambient temperature		-25 ... 60 °C (-13 ... 140 °F)
Storage temperature		-40 ... 70 °C (-40 ... 158 °F)
Mechanical specifications		
Degree of protection		IP67
Connection		3-pin, M12 x 1 connector
Material		
Housing		PC
Optical face		PMMA
Connector		plastic
Mass		approx. 10 g

**Connection Assignment**

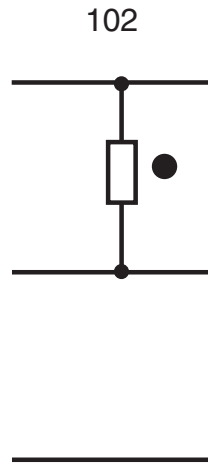
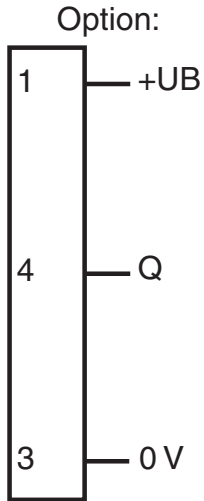

○ = Light on  
● = Dark on

**Connection Assignment**

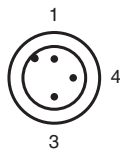

Wire colors in accordance with EN 60947-5-2

1	BN	(brown)
3	BU	(blue)
4	BK	(black)

**Assembly**

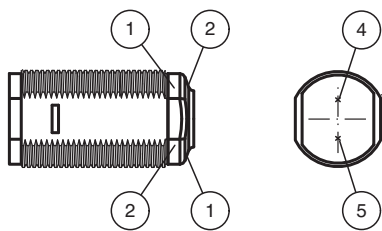

1	Operating display	green
2	Signal display	yellow
4	Emitter	
5	Receiver	

Release date: 2020-12-03 Date of issue: 2020-12-03 Filename: 188557\_eng.pdf

Refer to "General Notes Relating to Pepperl+Fuchs Product Information".

**Characteristic Curve**

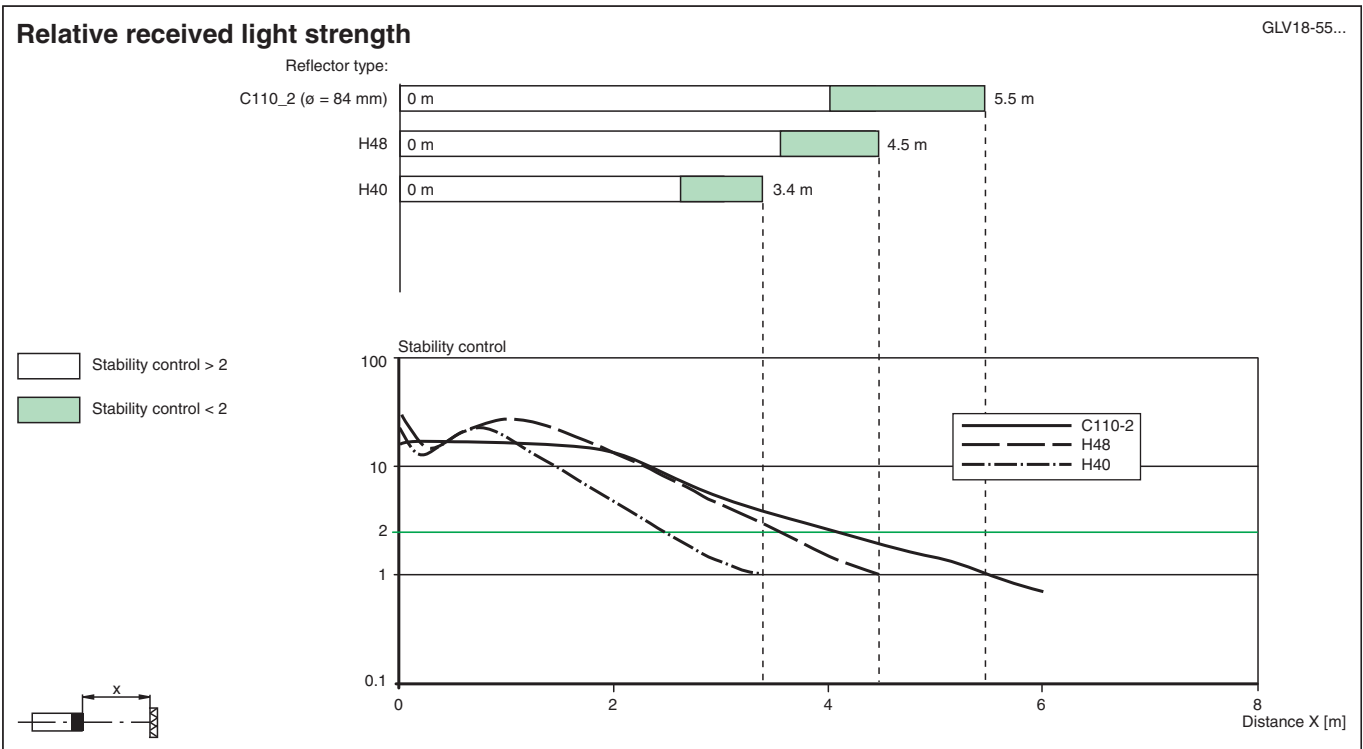
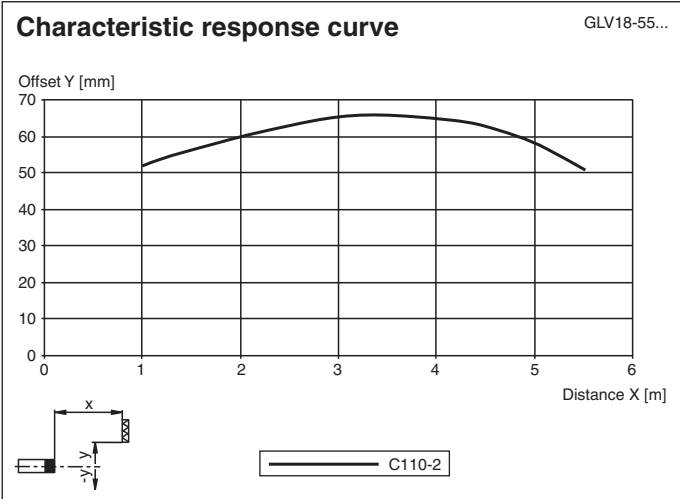

**Application**



Release date: 2020-12-03 Date of issue: 2020-12-03 Filename: 186557\_eng.pdf

Refer to "General Notes Relating to Pepperl+Fuchs Product Information".

Pepperl+Fuchs Group  
www.pepperl-fuchs.com





USA: +1 330 486 0001  
fa-info@us.pepperl-fuchs.com

Germany: +49 621 776 1111  
fa-info@de.pepperl-fuchs.com

Singapore: +65 6779 9091  
fa-info@sg.pepperl-fuchs.com

**PF PEPPERL+FUCHS**

## Accessories

	<b>CPZ18B03</b>	Mounting Bracket with swivel nut
	<b>BF 18</b>	Mounting flange, 18 mm
	<b>BF 18-F</b>	Plastic mounting adapter, 18 mm
	<b>BF 5-30</b>	Universal mounting bracket for cylindrical sensors with a diameter of 5 ... 30 mm
	<b>V11-G-2M-PUR</b>	Female cordset, M12, 3-pin, PUR cable

## Accessories

Other suitable accessories can be found at [www.pepperl-fuchs.com](http://www.pepperl-fuchs.com)

## Application

### **Packaging industry:**

- Presence checks, track loading, completeness checks, stack height control

### **Material handling**

- Presence checks, target sensor, profile checks, trigger sensor

### **Automatic doors, gates and access systems, elevator:**

- Secure detection for automatic door and gate systems
- Monitoring function in turnstiles
- Closing edge monitoring in elevators